

KOMATSU®

D65EX-18 **D65PX-18** **D65WX-18**

Tier 4 Final Engine
(Serial Numbers 90997 and up)

CRAWLER DOZER



Photos may include optional equipment.

D65

NET HORSEPOWER

217 HP @ 1950 rpm
162 kW @ 1950 rpm

OPERATING WEIGHT

SIGMADOZER®

D65EX-18: 46,892 lb 21270 kg
D65WX-18: 50,618 lb 22960 kg

Straight Tilt Dozer

D65PX-18: 50,331 lb 22830 kg

Power Angle Tilt Dozer

D65EX-18: 50,706 lb 23000 kg
D65PX-18: 51,963 lb 23570 kg
D65PX-18 Wide: 53,925 lb 24460 kg
D65WX-18: 52,801 lb 23950 kg

BLADE CAPACITY

SIGMADOZER®

D65EX-18: 7.3 yd³ 5.6 m³
D65WX-18: 7.7 yd³ 5.9 m³

Straight Tilt Dozer

D65PX-18: 4.8 yd³ 3.7 m³

Power Angle Tilt Dozer

D65EX-18: 5.6 yd³ 4.3 m³
D65PX-18: 5.8 yd³ 4.4 m³
D65PX-18 Wide: 5.8 yd³ 4.4 m³
D65WX-18: 5.8 yd³ 4.4 m³

WALK-AROUND

D65EX/PX/WX-18



NET HORSEPOWER

217 HP @ 1950 rpm
162 kW @ 1950 rpm

OPERATING WEIGHT

SIGMADOZER®
 D65EX-18: 46,892 lb 21270 kg
 D65WX-18: 50,618 lb 22960 kg
Straight Tilt Dozer
 D65PX-18: 50,331 lb 22830 kg
Power Angle Tilt Dozer
 D65EX-18: 50,706 lb 23000 kg
 D65PX-18: 51,963 lb 23570 kg
 D65PX-18 Wide: 53,925 lb 24460 kg
 D65WX-18: 52,801 lb 23950 kg

BLADE CAPACITY

SIGMADOZER®
 D65EX-18: 7.3 yd³ 5.6 m³
 D65WX-18: 7.7 yd³ 5.9 m³
Straight Tilt Dozer
 D65PX-18: 4.8 yd³ 3.7 m³
Power Angle Tilt Dozer
 D65EX-18: 5.6 yd³ 4.3 m³
 D65PX-18: 5.8 yd³ 4.4 m³
 D65PX-18 Wide: 5.8 yd³ 4.4 m³
 D65WX-18: 5.8 yd³ 4.4 m³

Photos may include optional equipment.



OUTSTANDING PRODUCTIVITY & FUEL ECONOMY

Versatile Power Angle Tilt (PAT) blade can be useful in many applications.

Innovative SIGMADOZER® blade reduces digging resistance and smoothly rolls material up for increased blade loads.

Transmission with 4 shift modes improves fuel economy and productivity:

- Auto shift, torque converter lockup ON
- Auto shift, torque converter lockup OFF
- Manual shift, auto-downshift ON
- Manual shift, auto-downshift OFF

SAA6D114E-6 diesel engine provides excellent fuel economy. This engine is EPA Tier 4 Final emissions certified.

Variable Geometry Turbocharger (VGT) uses a hydraulic actuator to provide optimum air flow under all speed and load conditions.

Includes a wide core A/C condenser and bowl-type precleaner on the cab air intake for improved performance in high debris applications.

Komatsu Diesel Particulate Filter (KDPF) captures 90% of particulate matter and provides automatic regeneration that does not interfere with daily operation.

Selective Catalytic Reduction (SCR) removes NOx exhaust gases automatically by injecting DEF (diesel exhaust fluid) and is seamless to the operator.

Auto Idle Shutdown helps reduce non-productive engine idle time and operating costs.

KOMTRAX® sends information to a secure website including machine location, SMR, error codes, cautions, maintenance items, fuel usage, fuel levels, DEF levels, ambient conditions and much more.

Integrated ROPS cab features include:

- Large, quiet, and pressurized cab
- Improved visibility with integrated ROPS structure
- Heated air-suspension seat with high capacity
- Aux plug for audio player and two 12 volt connections

Large color monitor:

- Easy-to-read and use large seven inch high-resolution multi-color monitor
- Ecology guidance
- On-board diagnostics

Rearview Monitoring System (standard) displays the area behind the machine onto the wide landscape view color monitor screen.

D65PX-18 Wide PAT specification features a **14'1"** (4295 mm) wide blade for maximum finish grading productivity and **36"** (915 mm) track shoes for optimum floatation.

Parallel Link Undercarriage System (PLUS) with lubricated rotating bushings provides up to double the wear life and lower repair and maintenance costs.



Triple Labyrinth Final Drive improves durability and final drive life.

Ergonomic Operator Controls

- Palm Command Control System (PCCS) levers comfortably fit the operator's hands
- Automatic/manual selectable transmission shift mode
- Selected transmission shift mode remains saved in the monitor at engine key-off/key-on
- Forward/reverse shift pattern preset function

Komatsu designed and manufactured components

Blade Electronic Proportional Control EPC Valve (standard)

Facilitates installation of aftermarket grade control system.

Hydrostatic Steering System (HSS) has 25% more power for improved turning and counter-rotation.

Power and Economy Modes

Choose "Power" for maximum productivity, "Economy" for an extra 10% fuel savings under moderate loads.

Battery Disconnect Switch

Eliminates power draw during storage.

Operator Identification System tracks machine operation for up to 6 operators.

PERFORMANCE FEATURES

KOMATSU NEW ENGINE TECHNOLOGIES

New Tier 4 Final Engine

The Komatsu SAA6D114E-6 engine is EPA Tier 4 Final emissions certified and provides exceptional performance while reducing fuel consumption. Based on Komatsu proprietary technologies developed over many years, this new diesel engine reduces nitrogen oxides (NOx) by more than 80% when compared to Tier 4 interim levels. Through the in-house development and production of engines, electronics, and hydraulic components, Komatsu has achieved great advancements in technology, providing high levels of performance and efficiency in virtually all applications.

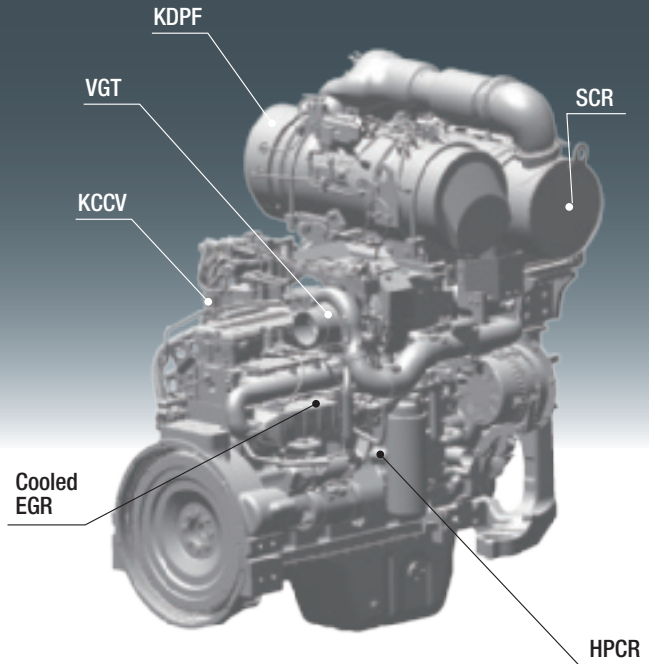

Technologies Applied to New Engine

Heavy-duty aftertreatment system

This new system combines a Komatsu Diesel Particulate Filter (KDPF) and Selective Catalytic Reduction (SCR). The SCR NOx reduction system injects the correct amount of DEF at the proper rate, thereby decomposing NOx into non-toxic water (H₂O) and nitrogen gas (N₂).

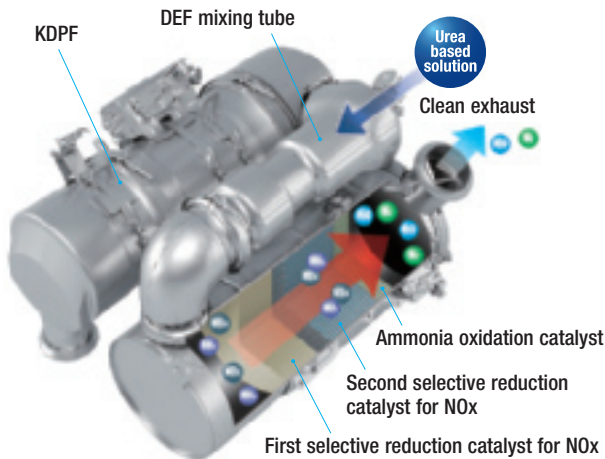

Advanced Electronic Control System

The electronic control system performs high-speed processing of all signals from sensors installed in the vehicle providing total control of equipment in all conditions of use. Engine condition information is displayed via an on-board network to the monitor inside the cab, providing necessary information to the operator. Additionally, managing the information via KOMTRAX helps customers keep up with required maintenance.

Variable Geometry Turbocharger (VGT) system

The VGT system features proven Komatsu design hydraulic technology for variable control of air-flow and supplies optimal air according to load conditions. The upgraded version provides better exhaust temperature management.

Heavy-duty cooled Exhaust Gas Recirculation (EGR) system

The system recirculates a portion of exhaust gas into the air intake and lowers combustion temperatures, thereby reducing NOx emissions. EGR gas flow has been decreased for Tier 4 Final with the addition of SCR technology. The system achieves a dynamic reduction of NOx, while helping reduce fuel consumption below Tier 4 Interim levels.

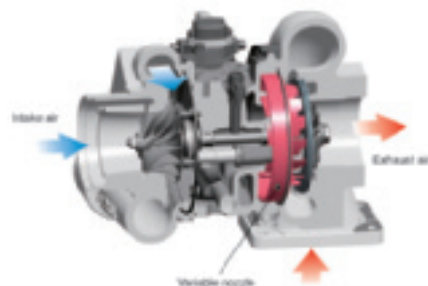
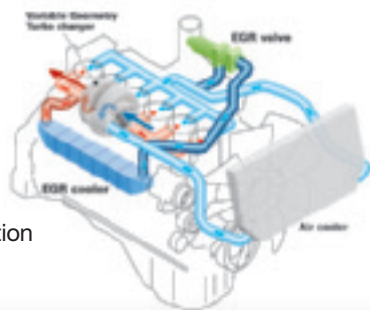

Komatsu Auto Idle Shutdown

Komatsu auto idle shutdown automatically shuts the engine down after idling for a set period of time to reduce unnecessary fuel consumption and exhaust emissions. The amount of time before the engine is shutdown can be easily programmed from five to 60 minutes.

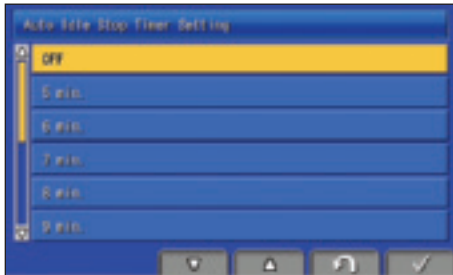

Secondary Engine Shutdown Switch

The secondary engine shutdown switch is located on the side of the front console.



Heavy-Duty High-Pressure Common Rail (HPCR) Fuel Injection System

The system is designed to achieve an optimal injection of high-pressure fuel by means of computerized control, providing close-to-complete combustion to reduce PM emissions. While this technology is already used in current engines, the new system uses high pressure injection, thereby reducing both PM emissions and fuel consumption over the entire range of engine operating conditions. The Tier 4 Final engine has advanced fuel injection timing for reduced fuel consumption and lower soot levels.

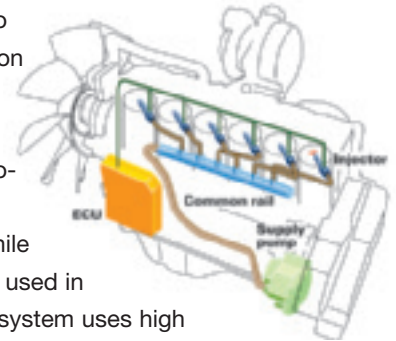

Hydraulically Driven Cooling Fan

The engine cooling fan speed is electronically controlled. The fan speed depends on engine coolant, powertrain oil and hydraulic oil temperatures. Higher temperatures create higher fan speed. The system increases fuel efficiency, reduces the operating noise levels and requires less horsepower than a belt driven fan. Operators can manually reverse the fan for periodic cleaning.



PRODUCTIVITY & FUEL ECONOMY FEATURES

- 1 Automatic transmission with lockup torque converter
- 2 KOMATSU SAA6D114E-6 engine
- 3 SIGMADOZER®

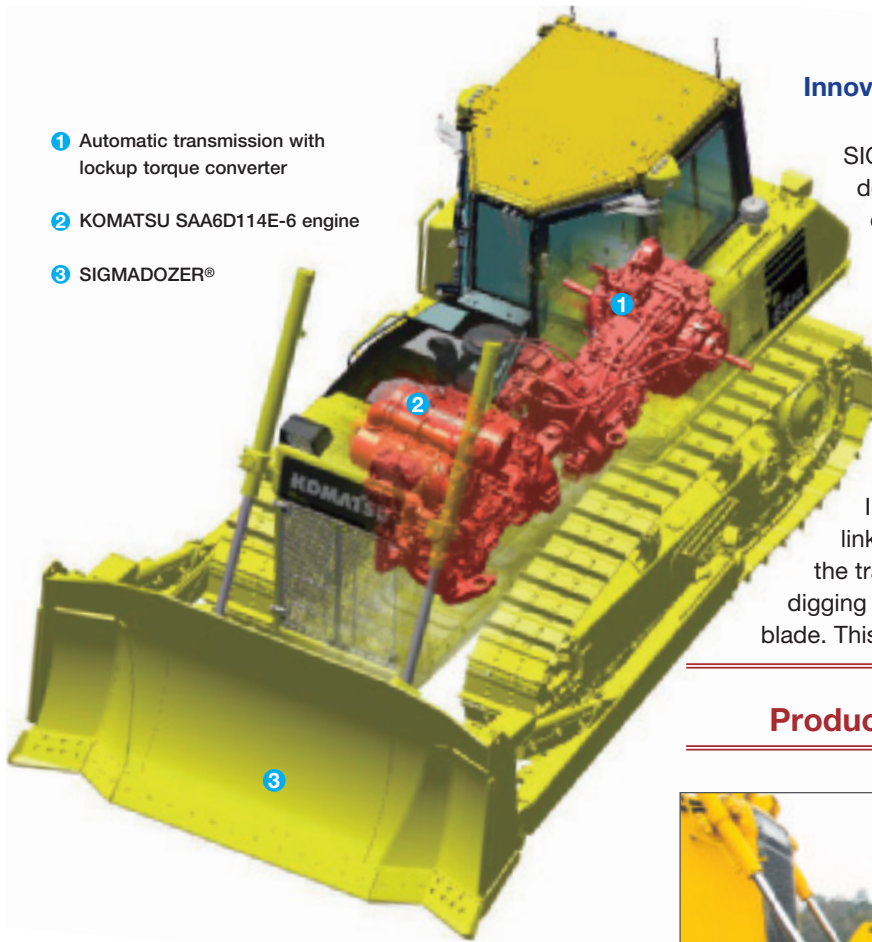

Innovative SIGMADOZER® (optional)

Based on a completely new design, SIGMADOZER® dramatically improves dozing performance and increases productivity. A new frontal design concept adopted for digging and rolling up at the center of the blade increases soil holding capacity and simultaneously reduces sideway spillage. Reduced digging resistance produces smoother flow of material, enabling the dozing of larger quantities of material with less power. In addition, adoption of a new blade linkage system holds the blade closer to the tractor for improved visibility, enhanced digging force and reduced lateral sway of the blade. This is the next generation of dozer blades.

Production increased by 15%

Compared to conventional Semi-U blade



SIGMADOZER®



Semi-U blade

Innovative Fuel Efficient Bulldozer

The D65EX/PX/WX-18 achieves high levels of productivity with the SIGMADOZER® blade, automatic transmission with lockup torque converter and Tier 4 Final engine. The SIGMADOZER® blade, based on a completely new design theory, dramatically increases production. Also, this bulldozer significantly improves fuel efficiency compared with our conventional model.

SIGMADOZER®



Automatic transmission with lockup torque converter



Tier 4 Final engine



FUEL EFFICIENCY:
30% increase

Compared to machine with Semi-U blade and manual shift transmission

Production Increased By

15%

(compared with a conventional Semi-U blade model)

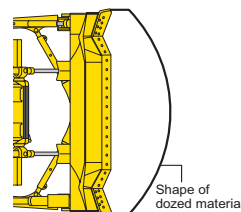

SIGMADOZER®

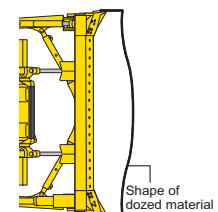

Semi-U blade

Automatic Transmission with Lockup Torque Converter

The automatic gear shift transmission and lockup torque converter creates a sharp reduction in fuel consumption and greater power train efficiency. Travel speed is automatically selected depending on working conditions and load. This allows the machine to operate at maximum efficiency. Operators can select manual shift mode with the flip of a switch.

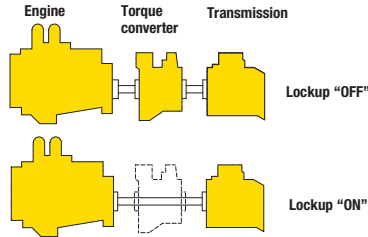

Fuel consumption reduced by 10%

Compared to machine with manual shift transmission

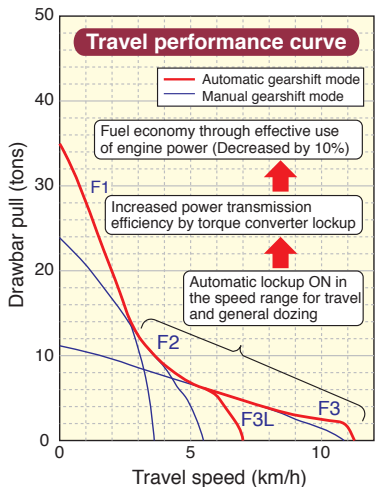

Lockup clutch of torque converter is automatically engaged to transfer engine power directly to the transmission in usual dozing speed range. Locking up the torque converter eliminates loss of horsepower by 10%. Because the electronically controlled engine is extremely efficient, a decrease in fuel consumption is realized while also maintaining machine power.

Power Angle Tilt (PAT) Dozer (optional)

The PAT dozer assembly features a strong box section C-frame and blade structure with steel castings at high stress areas. The moldboard is made of abrasion resistant steel for long wear life. Available on EX, WX, PX, and PX wide PAT machines, this 6-way blade with manual variable pitch offers versatility and productivity in a variety of applications.

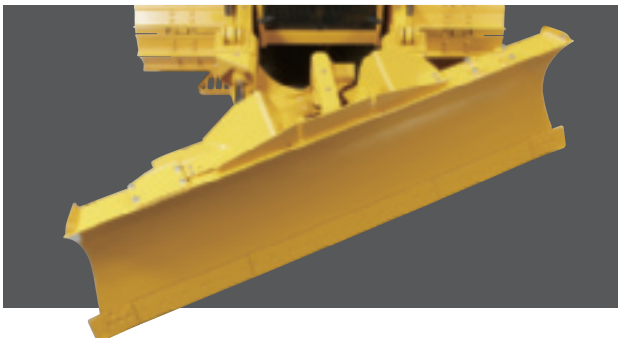

Automatic/Manual Gearshift Modes

Operators can select from two automatic and two manual gearshift modes to suit the work at hand. Change mode by simply pressing a monitor button. The selected shift mode remains saved at engine ignition key-off/key-on.

Auto shift torque converter lockup OFF

Newly added mode for heavy dozing. The transmission quickly upshifts and downshifts automatically to maximize productivity under the heaviest loads.

Auto shift torque converter lockup ON

General dozing mode to optimize fuel economy, the transmission upshifts and downshifts automatically based on load. Under certain conditions, the torque converter lockup clutch actuates to create a direct connection between the engine and tracks.

Manual shift auto-downshift ON

In this heavy dozing and ripping mode the transmission automatically shifts down to avoid overheating, but does not shift up when the load is off.

Manual shift auto-downshift OFF

When finish grading, this mode causes the transmission to remain in the selected travel gear until another gear is selected. Smooth and precise grading work can be achieved.

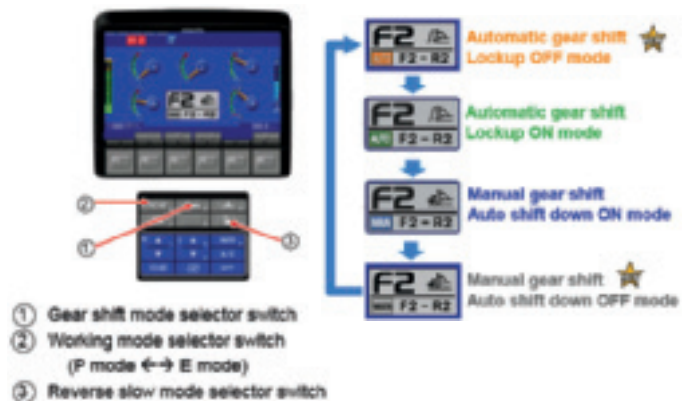

Selectable Working Mode

Working Mode P aims for powerful operation and maximum production. E Mode is for general dozing applications with adequate speed and power while saving fuel. The monitor panel allows the operator to switch the working mode with ease depending on the work at hand.

P Mode (Power mode)

With P mode, the engine outputs its full power, allowing the machine to perform large production, heavy-load and uphill work.

E Mode (Economy mode)

With E mode, the engine generates the power needed without delivering unnecessary power. The mode allows for fuel efficient operation and is best matched to work that may cause shoe slip and work not requiring maximum power, such as downhill dozing, leveling and light load work.

CONTROL FEATURES

Palm Command Electronic Controlled Travel Control Joystick

The palm command travel joystick allows the operator to adopt a relaxed posture and offers superb fine control without operator fatigue. Transmission gear shifting is simplified with thumb push buttons.

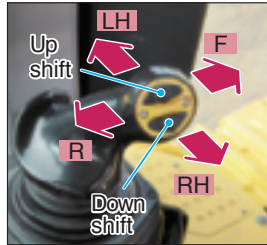

Travel Speed Preset Function

Forward and reverse travel speeds can be preset when the travel joystick is placed in neutral. Available F-R preset patterns are shown in the diagram below. The transmission automatically shifts to the preset gear when the travel lever moves to the Forward or Reverse position, thereby avoiding repeated manual upshifts and operator fatigue.



Automatic gearshift mode

- F1-R1 MODE**
Press DOWN switch ↑ ↓ Press UP switch
- F1-R2 MODE**
Press DOWN switch ↑ ↓ Press UP switch
- F2-R1 MODE**
Press DOWN switch ↑ ↓ Press UP switch
- F2-R2 MODE**
Press DOWN switch ↑ ↓ Press UP switch
- F2-R3L MODE**
Press DOWN switch ↑ ↓ Press UP switch
- F3L-R3L MODE**

Manual gearshift mode

- F1-R1 MODE**
Press DOWN switch ↑ ↓ Press UP switch
- F1-R2 MODE**
Press DOWN switch ↑ ↓ Press UP switch
- F2-R1 MODE**
Press DOWN switch ↑ ↓ Press UP switch
- F2-R2 MODE**
Press DOWN switch ↑ ↓ Press UP switch
- F2-R3 MODE**

Electronic Controlled Modulation Valve (ECMV) Controlled Transmission and Brakes

Controller automatically adjusts each clutch shift depending on travel conditions, providing smooth shockless clutch engagement, improved component life and operator ride comfort.

Enhanced Hydrostatic Steering System (HSS) -Smooth, Powerful Turning

Engine power is transmitted to both tracks as the dozer turns. Steering power has been increased 25% by a larger HSS motor, increased hydraulic pump flow, and increased engine horsepower while steering. The result is quicker, tighter turns and improved counter-rotation.



D65EX/PX/WX-18

WORKING ENVIRONMENT



Integrated ROPS Cab

The D65EX/PX/WX-18 cab meets:
 ROPS standard ISO 3471:2008
 FOPS Level 2 standard ISO 3449:2005
 High rigidity and superb sealing reduces noise and vibration for the operator. The pressurized, climate controlled cab helps provide the operator with a fresh and clean working environment. Also, operators enjoy more side visibility because additional external ROPS posts are not required.



Comfortable Ride for the Operator

The operator seat features an air-suspension, lumbar support, a tilt adjust function and electric heater. The seat easily adjusts to fit operator shape and working conditions. Also the heated seat allows operators to work comfortably in the winter.

Operator cab mounts incorporate a damper that softens shock and vibration while travelling over adverse ground conditions. This isolates the cab from the machine body and provides a comfortable operating environment that conventional mounting systems cannot match.

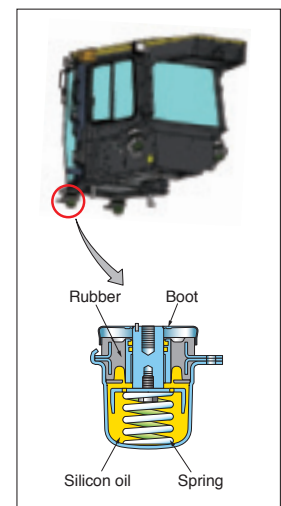

Rearview Monitoring System

The operator can view the rear of the machine on a color monitor. The camera can be synchronized with the travel lever to display rearview when in reverse.

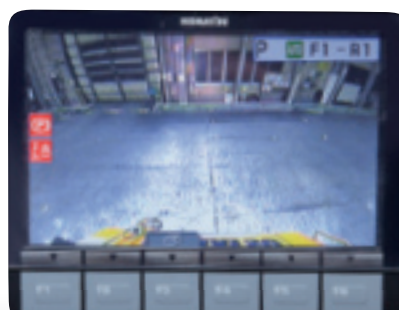

RELIABILITY & MAINTENANCE FEATURES

Parallel Link Undercarriage System (PLUS)

Komatsu's innovative Parallel Link Undercarriage System features a rotary bushing that demonstrates high durability in any working condition. Allowing the bushing to rotate virtually eliminates bushing wear, resulting in doubled service life of the undercarriage when compared with the conventional undercarriage. In addition, wear limits of the link and carrier roller are increased to balance with the extended service life of the bushing.

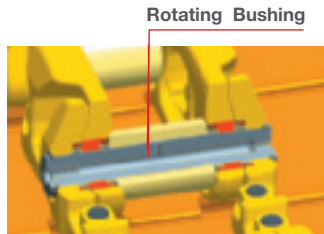

Self-adjusting Idler Support

Self-adjusting idler support applies a constant spring force to the wear plate of the idler guide to eliminate the play of the idler. This results in reduced noise and vibration, as well as extended service life of the wear plate.

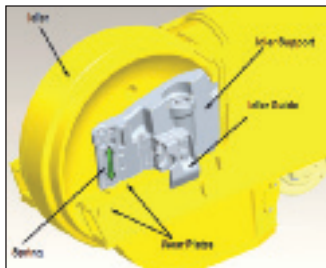

Oil Pressure Checking Ports

Pressure checking ports for power train components are centralized to promote quick and simple diagnosis.

Wide Core Cooling System

In addition to improved engine compartment sealing, a wide core cooling system is standard. Radiator, oil cooler and charge air cooler use large square-wave fins spaced at 6 fins per inch. This allows more material to pass through, which helps self-cleaning and reduces maintenance.

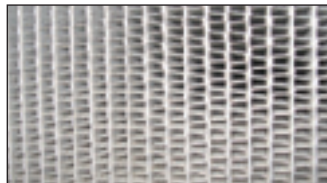

Multi-monitor with Troubleshooting Feature to Help Prevent Critical Machine Trouble

Various meters, gauges and warning functions are centrally arranged on the multi-monitor. The monitor simplifies start-up inspection and promptly warns the operator with a lamp and buzzer if any abnormalities should occur. In addition, countermeasures are indicated in four levels to help prevent major problems. Replacement times for oil and filters are also indicated.



Maintenance

When the machine reaches the replacement interval for oil and filters, the monitor panel will display lights to inform the operator.

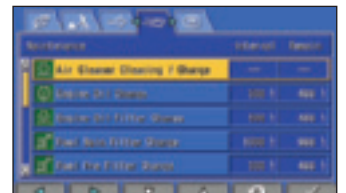

Battery Disconnect Switch

A standard battery disconnect switch allows a technician to disconnect the power supply before servicing the machine.

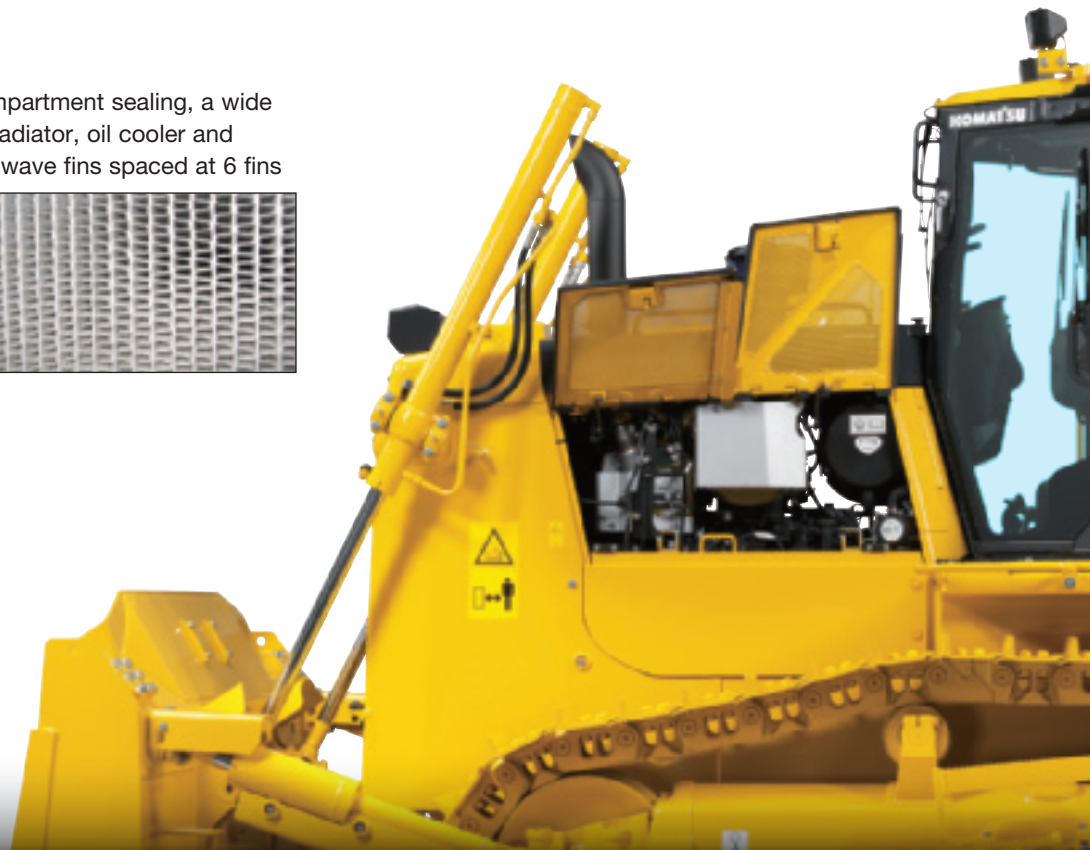

D65EX/PX/WX-18

KOMTRAX EQUIPMENT MONITORING

GET THE WHOLE STORY WITH
KOMTRAX[®]

✓ WHAT

- KOMTRAX is Komatsu's remote equipment monitoring and management system
- KOMTRAX **continuously monitors and records** machine health and operational data
- Information such as fuel consumption, utilization, and a detailed history **lowering owning and operating cost**

✓ WHO

- KOMTRAX is **standard** equipment on all Komatsu construction products

✓ WHEN

- Know when your machines are **running or idling** and make decisions that will improve your fleet utilization
- Detailed movement records ensure you know when and where your equipment is moved
- Up to date records allow you to **know when maintenance is due** and help you plan for future maintenance needs

✓ WHERE

- KOMTRAX data **can be accessed virtually anywhere** through your computer, the web or your smart phone
- Automatic alerts keep fleet managers up to date on the latest machine notifications

✓ WHY

- Knowledge is power - **make informed decisions** to manage your fleet better
- Knowing your idle time and fuel consumption will help maximize your machine efficiency
- **Take control of your equipment** - any time, anywhere



KOMTRAX[®]

For construction and compact equipment.

KOMTRAX Plus[®]

For production and mining class machines.

KOMATSU PARTS & SERVICE SUPPORT



KOMATSU CARE®

Program Includes:

*The D65EX/PX/WX-18 comes standard with complimentary factory scheduled maintenance for the first 3 years or 2,000 hours, whichever comes first.

Planned Maintenance Intervals at:

500/1000/1500/2000 hour intervals. (250 hr. initial interval for some products) Complimentary Maintenance Interval includes: Replacement of Oils & Fluid Filters with genuine Komatsu Parts, 50-Point inspection, Komatsu Oil & Wear Analysis Sampling (KOWA) / Travel & Mileage (distance set by distributor; additional charges may apply).

Benefits of Using Komatsu CARE

- Assurance of Proper Maintenance with OEM Parts & Service
- Increased Uptime & Efficiency
- Factory Certified Technicians Performing Work
- Cost of Ownership Savings
- Transferable Upon Resale

Complimentary KDPF System Maintenance

The D65EX/PX/WX-18 comes standard with 2 Complimentary KDPF Exchange Units for the first 5 years at the suggested KDPF Exchange Units Service Intervals of 4,500 hours and 9,000 hours during the first 5 years. End User must have authorized Komatsu distributor perform the removal and installation of the KDPF.

Complimentary SCR System Maintenance

The D65EX/PX/WX-18 also includes 2 factory recommended services of the Selective Catalytic Reduction (SCR) Diesel exhaust fluid (DEF) system during the first 5 years—including:

- Factory recommended DEF tank flush and strainer cleaning at 4,500 hours and 9,000 hours

Komatsu CARE® – Advantage Extended Coverage

- Extended Coverage can provide peace of mind by protecting customers from unplanned expenses that effect cash flow
- Purchasing extended coverage locks-in the cost of covered parts and labor for the coverage period and helps turn these into fixed costs



Komatsu Oil and Wear Analysis (KOWA)

- KOWA detects fuel dilution, coolant leaks, and measures wear metals
- Proactively maintain your equipment
- Maximize availability and performance
- Can identify potential problems before they lead to major repairs
- Reduce life cycle cost by extending component life

KOMATSU CARE D65EX/PX/WX-18				
Interval PM	500	1000	1500	2000
KOWA SAMPLING – (Engine, Hydraulics, L & R Final Drives)	✓	✓	✓	✓
LUBRICATE MACHINE	✓	✓	✓	✓
CHANGE ENGINE OIL	✓	✓	✓	✓
REPLACE ENGINE OIL FILTER	✓	✓	✓	✓
REPLACE FUEL PRE-FILTER	✓	✓	✓	✓
CLEAN FUEL STRAINER	✓	✓	✓	✓
REPLACE POWER TRAIN OIL FILTER	✓	✓	✓	✓
DRAIN FUEL TANK SEDIMENT	✓	✓	✓	✓
REPLACE A/C FRESH & RECIRCULATION FILTERS	✓	✓	✓	✓
CLEAN AIR CLEANER ELEMENT	✓	✓	✓	✓
COMPLETE 50 POINT INSPECTION FORM; LEAVE PINK COPY WITH CUSTOMER OR IN CAB	✓	✓	✓	✓
RESET MONITOR PANEL MAINTENANCE COUNTER FOR APPROPRIATE ITEMS	✓	✓	✓	✓
REPLACE FUEL MAIN FILTER		✓		✓
CHANGE POWER TRAIN OIL		✓		✓
CLEAN POWER TRAIN STRAINER		✓		✓
CLEAN SCAVENGING PUMP STRAINER		✓		✓
CHECK DAMPER CASE OIL LEVEL		✓		✓
CHANGE FINAL DRIVE OIL		✓		✓
REPLACE HYDRAULIC TANK BREATHER ELEMENT		✓		✓
REPLACE FUEL TANK BREATHER ELEMENT		✓		✓
REPLACE DEF TANK BREATHER ELEMENT		✓		✓
CLEAN POWER TRAIN CASE BREATHER		✓		✓
CHANGE HYDRAULIC OIL				✓
REPLACE HYDRAULIC FILTER				✓
CLEAN HYDRAULIC TANK STRAINER				✓
CHANGE DAMPER CASE OIL				✓
REPLACE KCCV FILTER				✓
REPLACE DEF FILTER				✓
FACTORY TRAINED TECHNICIAN LABOR	✓	✓	✓	✓
2 KDPF Exchanges at 4,500 Hrs and 9,000 Hrs.				
2 SCR System Maintenance Services at 4,500 Hrs. and 9,000 Hrs.				

Komatsu Parts Support

- 24/7/365 to fulfill your parts needs
- 9 parts Distribution Centers strategically located across the U.S. and Canada
- Distributor network of more than 300 locations across U.S. and Canada to serve you
- Online part ordering through Komatsu eParts
- Remanufactured components with same-as-new warranties at a significant cost reduction



* Certain exclusions and limitations apply. Refer to the customer certificate for complete program details and eligibility. Komatsu® and Komatsu Care® are registered trademarks of Komatsu Ltd. Copyright 2018 Komatsu America Corp.

D65EX/PX/WX-18

SPECIFICATIONS



ENGINE

Model.....Komatsu SAA6D114E-6*
 Type..... 4-cycle, water-cooled, direct injection
 Aspiration..... Variable geometry turbocharged, air-to-air aftercooled
 Number of cylinders..... 6
 Bore x stroke..... 114 mm x 144.5 mm **4.49" x 5.69"**
 Piston displacement..... 8.85 ltr **540 in³**
 Governor..... All-speed and mid-range, electronic
 Horsepower
 SAE J1995..... Gross 164 kW **220 HP**
 ISO 9249 / SAE J1349..... Net 162 kW **217 HP**
 Rated rpm..... 1950 rpm
 Fan drive type..... Variable speed hydraulic
 Lubrication system
 Method..... Gear pump, force lubrication
 Filter..... Full-flow

**EPA Tier 4 Final emissions certified



TORQFLOW TRANSMISSION

Komatsu TORQFLOW transmission consists of a water-cooled, 3-element, 1-stage, 2-phase, torque converter with lockup clutch, and a planetary gear, multiple-disc clutch transmission, which is electronically controlled, hydraulically actuated and force-lubricated for optimum heat dissipation. Shift lock lever and neutral safety switch.

Travel speed	Forward	Reverse
1st	3.7 km/h 2.3 mph	4.5 km/h 2.8 mph
2nd	5.6 km/h 3.5 mph	6.7 km/h 4.2 mph
3rd L	7.3 km/h 4.5 mph	8.7 km/h 5.4 mph
3rd	11.3 km/h 7.0 mph	13.6 km/h 8.5 mph

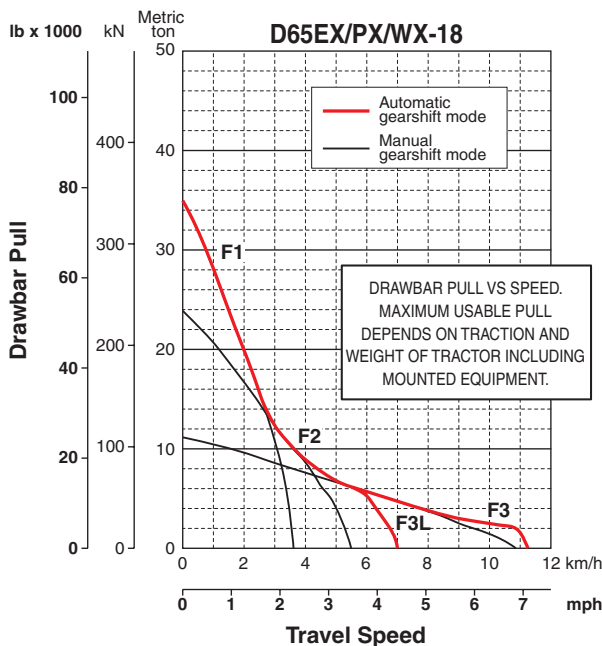

STEERING SYSTEM

Palm Command Control System (PCCS) lever controls for all directional movements. Pushing the PCCS lever forward results in forward machine travel, while pulling it rearward reverses the machine. Simply tilt the PCCS lever to the left for a left turns, tilt it right for right turns.

Hydrostatic Steering System (HSS) power has been increased 25% by a larger HSS motor, greater hydraulic pump flow, and more engine power while steering. The result is more powerful turns and quicker counter-rotation. Wet, multiple-disc, pedal-controlled service brakes are spring-actuated and hydraulically released.

Gear shift lock lever also applies parking brake.

Minimum turning radius

D65EX-18.....	1.9 m 6'3"
D65EX-18 with PAT.....	2.0 m 6'7"
D65PX-18.....	2.2 m 7'3"
D65WX-18.....	2.1 m 6'11"



UNDERCARRIAGE

Suspension..... Oscillating equalizer bar and pivot shaft
 Track roller frame..... Monocoque, large section, durable construction

Rollers and idlers..... Lubricated

Track shoes

Parallel Link Undercarriage System (PLUS) with lubricated rotating bushings for extended system wear life and lower maintenance costs. Track tension is easily adjusted with a grease gun.

Tractor for outside mounted blade (Straight Tilt, SIGMADOZER®)*

	D65EX-18	D65WX-18	D65PX-18
Number of track rollers (each side)	7	7	8
Type of shoes (standard)	MS PLUS	MS PLUS	MS PLUS
Number of shoes (each side)	42	42	45
Grouser height	mm in 65 2.6"	65 2.6"	65 2.6"
Shoe width (standard)	mm in 610 24"	760 30"	915 36"
Ground contact area (ISO 16754)	cm ² 40910	50969	66946
	in ² 6,341	7,900	10,377
Ground pressure (tractor) (ISO 16754)	kPa 44.1	38.4	29.6
	kgf/cm ² 0.45	0.39	0.3
	psi 6.4	5.57	4.29
Track gauge	mm ft.in 1880 6'2"	2050 6'9"	2050 6'9"
Length of track on ground	mm ft.in 2970 9'9"	2970 9'9"	3275 10'9"

Tractor for inside mounted blade (PAT)*

	D65EX-18	D65WX-18	D65PX-18	D65PX-18 Wide
Number of track rollers (each side)	7	7	8	8
Type of shoes (standard)	MS PLUS	MS PLUS	MS PLUS	ES PLUS Clipped
Number of shoes (each side)	42	42	45	45
Grouser height	mm in 65 2.6"	65 2.6"	65 2.6"	65 2.6"
Shoe width (standard)	mm in 560 22"	760 30"	760 30"	915 36"
Ground contact area (ISO 16754)	cm ² 37556	50969	55605	66946
	in ² 5,821	7,900	8,619	10,377
Ground pressure (tractor) (ISO 16754)	kPa 54.7	42.1	38	32.7
	kgf/cm ² 0.56	0.43	0.39	0.33
	psi 7.93	6.11	5.51	4.74
Track gauge	mm ft.in 2050 6'9"	2230 7'4"	2230 7'4"	2385 7'10"
Length of track on ground	mm ft.in 2970 9'9"	2970 9'9"	3275 10'9"	3275 10'9"

*See page 14 for tractor/blade combinations.

MS: Moderate Service shoe, ES: Extreme Service shoe, Clipped: Clipped grouser

SPECIFICATIONS



FINAL DRIVES

Double-reduction planetary gear final drives increase drawbar pull and reduce stresses for longer life. Segmented sprocket teeth are bolt-on for easy replacement. Triple labyrinth housing protects the final drive seals.



HYDRAULIC SYSTEM

Closed-center load sensing system (CLSS) designed for precise and responsive control, and for efficient simultaneous operation.

Hydraulic control units:

All spool valves externally mounted beside the hydraulic tank.

Piston type hydraulic pump with capacity (discharge flow) of 248 ltr/min **65.5 U.S. gal/min** at rated engine rpm.

Relief valve setting 27.9 MPa 285 kg/cm² **4,050 psi**

Control valves:

Spool control valves for SIGMADOZER® or straight tilt dozer

Positions: Blade lift Raise, hold, lower, and float

Blade tilt Right, hold, and left

Rear attachment..... Raise, hold, and lower



SERVICE REFILL CAPACITIES

Fuel tank	415 ltr	109.6 U.S. gal
DEF tank	23.5 ltr	6.2 U.S. gal
Coolant	49 ltr	12.9 U.S. gal
Engine.....	30.5 ltr	8.1 U.S. gal
Torque converter, transmission, bevel gear, and steering system		
	48 ltr	12.7 U.S. gal
Final drive (each side)		
D65EX-18 non PAT	16.5 ltr	4.4 U.S. gal
D65EX-18 with PAT	22 ltr	5.8 U.S. gal
D65PX-18	22 ltr	5.8 U.S. gal
D65WX-18	22 ltr	5.8 U.S. gal

Spool control valves for Power Angle Tilt dozer

Positions: Blade lift Raise, hold, lower, and float

Blade tilt Right, hold, and left

Blade angle Right, hold, and left

Rear attachment..... Raise, hold, and lower

Hydraulic cylinders..... Double-acting, piston

	Number of cylinders	Bore	
		SIGMADOZER® Straight Tilt Dozer	Power Angle Power Tilt Dozer
Blade lift	2	85 mm 3.3"	90 mm 3.5"
Blade tilt	1	125 mm 4.9"	130 mm 5.1"
Blade angle	2	N/A	110 mm 4.3"
Ripper lift	1	125 mm 4.9"	125 mm 4.9"
Pitch angle	1	39° - 53°	52° - 58°

Hydraulic oil capacity (refill):..... 62 ltr **16.4 U.S. gal**

Ripper equipment (additional volume):

Multi-shank ripper 7 ltr **1.8 U.S. gal**



DOZER EQUIPMENT

Blade capacities per SAE J1265. Moldboard constructed from high tensile abrasion resistant steel.

	Overall Length With Dozer mm ft.in	Blade Capacity m ³ yd ³	Blade Width x Height mm ft.in	Max. Lift Above Ground mm ft.in	Max. Drop Below Ground mm ft.in	Max. Tilt Adjustment mm ft.in	Weight Dozer Equipment kg lb	Ground Pressure* ISO 16754 kPa kg/cm ² psi
D65EX-18 SIGMADOZER®	5490 18'0"	5.61 7.34	3410 x 1425 11'2" x 4'8"	1135 3'9"	500 1'8"	870 2'10"	2390 5,260	50.0/0.51/ 7.25
D65EX-18 Semi-U Dozer	5330 17'6"	5.61 7.34	3470 x 1425 11'5" x 4'8"	1105 3'8"	430 1'5"	870 2'10"	2375 5,236	50.0/0.51/ 7.25
D65EX-18 Power Angle Tilt Dozer	5790 19'0"	4.25 5.56	3870 x 1235 12'8" x 4'1"	1170 3'10"	695 2'3"	500 1'8"	2960 6,530	58.9/0.60/ 8.54
D65PX-18 Straight Tilt Dozer	5680 18'8"	3.69 4.83	3970 x 1100 13'0" x 3'7"	1130 3'8"	535 1'9"	890 2'11"	2100 4,630	32.8/0.33/ 4.76
D65PX-18 Power Angle Tilt Dozer	5790 19'0"	4.42 5.78	4010 x 1235 13'2" x 4'1"	1170 3'10"	695 2'3"	520 1'8"	2990 6,590	40.8/0.42/ 5.91
D65PX-18 Wide Power Angle Tilt Dozer	5790 19'0"	4.42 5.78	4295 x 1188 14'1" x 3'11"	1170 3'10"	695 2'3"	560 1'10"	3200 7,055	35.1/0.36/ 5.10
D65WX-18 SIGMADOZER®	5500 18'1"	5.90 7.72	3580 x 1425 11'9" x 4'8"	1135 3'9"	500 1'8"	770 2'6"	2500 5,510	43.3/0.44/ 6.28
D65WX-18 Power Angle Tilt Dozer	5790 19'0"	4.42 5.78	4010 x 1235 13'2" x 4'1"	1170 3'10"	695 2'3"	520 1'8"	2990 6,590	45.2/0.46/ 6.55

* Ground pressure shows tractor, ROPS cab, full fluids, operator, standard equipment and applicable blade (EX, WX, PAT with counterweight).
Ground pressure per ISO 16754



DIMENSIONS — OUTSIDE MOUNTED DOZER BLADE

	D65EX-18 SIGMADOZER®	D65WX-18 SIGMADOZER®	D65PX-18 Straight Tilt Dozer
A	5490 mm 18'0"	5500 mm 18'1"	5680 mm 18'8"
B	1880 mm 6'2"	2050 mm 6'9"	2050 mm 6'9"
C	3160 mm 10'5" **	3160 mm 10'5" **	3160 mm 10'5" **
D	3085 mm 10'1"	3085 mm 10'1"	3085 mm 10'1"
E	2970 mm 9'9"	2970 mm 9'9"	3275 mm 10'9"
F	610 mm 24"	760 mm 30"	915 mm 36"
G	65 mm 2.6"	65 mm 2.6"	65 mm 2.6"
H	4065 mm 13'4"	4065 mm 13'4"	4370 mm 14'4"

*3350 mm **11'0"** is overall height if Komatsu sweeps are installed.

Ground clearance 415 mm **16"**

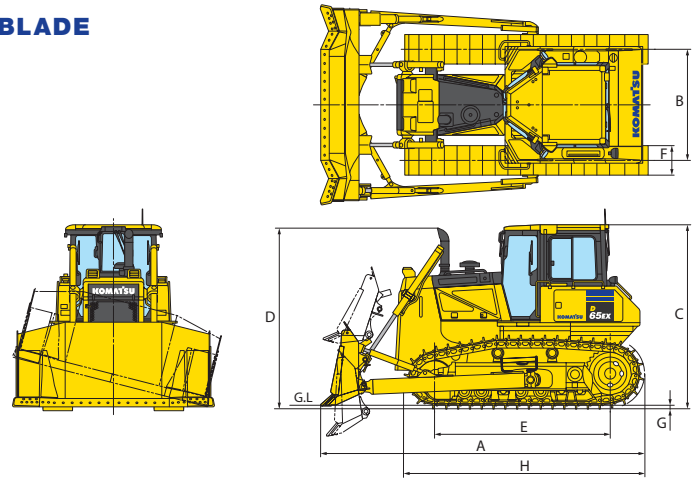

Shown with SIGMADOZER® (D65EX-18) single grouser shoe.



DIMENSIONS — PAT DOZER BLADE

	D65EX-18 PAT Dozer	D65WX-18 PAT Dozer	D65PX-18 PAT Dozer	D65PX-18 Wide PAT Dozer
A	5790 mm 19'0"	5790 mm 19'0"	5790 mm 19'0"	5790 mm 19'0"
B	2050 mm 6'9"	2230 mm 7'4"	2230 mm 7'4"	2385 mm 7'10"
C	3160 mm 10'5" **	3160 mm 10'5" **	3160 mm 10'5" **	3160 mm 10'5" **
D	3085 mm 10'1"	3085 mm 10'1"	3085 mm 10'1"	3085 mm 10'1"
E	2970 mm 9'9"	2970 mm 9'9"	3275 mm 10'9"	3275 mm 10'9"
F	560 mm 22"	760 mm 30"	760 mm 30"	915 mm 36"
G	65 mm 2.6"	65 mm 2.6"	65 mm 2.6"	65 mm 2.6"
H	3545 mm 11'8"	3627 mm 11'11"	3627 mm 11'11"	3925 mm 12'11"
I	4065 mm 13'4"	4065 mm 13'4"	4370 mm 14'4"	4370 mm 14'4"

*3350 mm **11'0"** is overall height if Komatsu sweeps are installed.

Ground clearance 415 mm **16"**

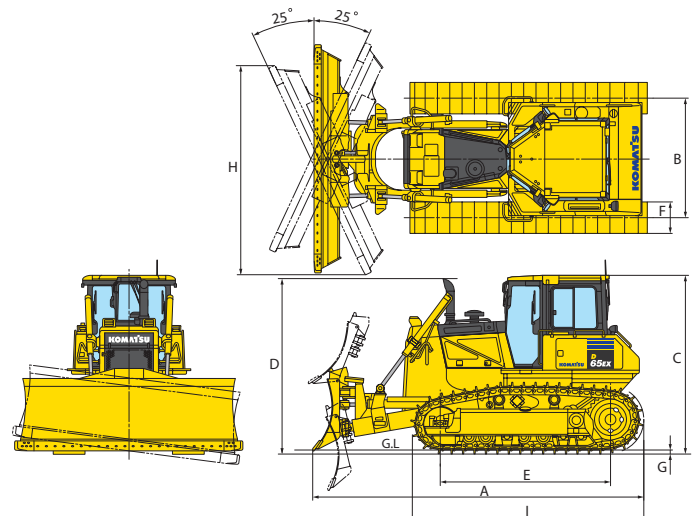

Shown with Power Angle Tilt dozer (D65EX-18) single grouser shoe.



OPERATING WEIGHT

Tractor shipping weights:

Shipping weight includes blade lift cylinders (C-frame for PAT, plus 840kg c'wt on EX/WX PAT), ROPS cab, standard track, lubricants, coolant.

EX Sigmadozer/SU.....	18780 kg	41,403 lb
EX PAT.....	21360 kg	47,091 lb
WX Sigmadozer.....	20360 kg	44,886 lb
WX PAT.....	22310 kg	49,185 lb
PX straight.....	20610 kg	45,437 lb
PX PAT.....	21950 kg	48,391 lb
PX Wide PAT.....	22730 kg	50,111 lb

Operating Weights:

Operating weight includes blade, hitch, (840 kg c'wt on EX/WX PAT), ROPS cab, standard track, lubricants, coolant, full fuel tank, and operator.

EX Sigmadozer/SU.....	21270 kg	46,892 lb
EX PAT.....	23000 kg	50,706 lb
WX Sigmadozer.....	22960 kg	50,618 lb
WX PAT.....	23950 kg	52,801 lb
PX straight.....	22830 kg	50,331 lb
PX PAT.....	23570 kg	51,963 lb
PX Wide PAT.....	24460 kg	53,925 lb



STANDARD EQUIPMENT FOR BASE MACHINE*

- Air cleaner, double element with dust indicator
- Alternator, 90 ampere/24V
- Auto idle shutdown function
- Backup alarm
- Batteries, 200 Ah/2 x 12V
- Battery disconnect switch
- Blade lift cylinders
- Color monitor, LCD
- Curved exhaust pipe
- Decelerator pedal
- Engine hood
- Engine intake centrifugal precleaner
- Engine, gull-wing side covers
- Engine shutdown secondary switch
- Fenders
- Front pull hook
- High mount foot rests
- Horn, warning
- Hydraulic driven radiator cooling fan with reverse clean mode
- Hydraulics for rear equipment
- KOMTRAX® Level 5
- Komatsu Diesel Particulate Filter (KDPF)
- Variable Geometry Turbocharger (VGT)
- Locks, filler caps and covers
- Oil pressure check ports for power train
- Operator ID function
- PM service connector
- Radiator mask, heavy-duty, hinged, perforated
- Rear cover
- ROPS cab**
 - 75 dB operator ear noise level
 - Air conditioner
 - Cab accessories
 - 12V power supply (2 ports)
 - Cup holder
 - Rearview mirror
 - Rearview monitoring (1 camera)
 - AM/FM Radio w/remote AUX plug (3.5 mm)
 - Shovel holder
 - Work lights
 - 2 front, hood mounted
 - 2 front, cab mounted
 - 1 rear, left fender mounted
 - 2 rear, cab mounted
- Seat, air suspension, fabric, heated low back, rotates 12.5° to right, headrest
- Seat belt, 76 mm **3"**, retractable
- Seat belt indicator
- Sealed electrical connectors
- Secondary engine shutoff switch
- Starting motor, 11.0 kW/24V
- Steering system:
 - Hydrostatic Steering System (HSS)
- Torque converter with auto lock-up
- Track roller guards, center and end sections
- Track shoe assembly
 - Heavy-Duty lubricated rotary bushing (PLUS) track
 - 560 mm **22"** MS shoe (EX with PAT)
 - 610 mm **24"** MS shoe (EX with outside mount blade)
 - 760 mm **30"** MS shoe (WX with outside mount blade)
 - 760 mm **30"** MS shoe (PX, WX with PAT)
 - 915 mm **36"** MS shoe (PX with outside mount blade)
 - 915 mm **36"** ES shoe (PX Wide PAT)
- Transmission with auto/manual shift modes
- Underguards, heavy duty
 - Hinged belly pan
 - Transmission
- Water separator
- Wide core cooling package

* Dozer assembly and rear mounted equipment are not included in base machine standard equipment
 ** Cab meets OSHA/MSHA ROPS and FOPS Level 2 standards



OPTIONAL EQUIPMENT

- Dozer assembly
- Drawbar, long type
- Hitch
- Rear counterweight 850 kg **1,870 lb**
- Straight tilt frame for use with allied blades
- Topcon® Plug-N-Play bolt-on finishing kit
- Track roller guard, full length

Multi-shank ripper (for D65EX/WX)

Weight.....	1920 kg	4,230 lb
Beam length.....	2170 mm	7'1"
Maximum lift above ground.....	640 mm	2'1"
Maximum digging depth.....	590 mm	1'11"



ALLIED MANUFACTURER'S ATTACHMENTS (SHIPPED LOOSE)

- Blade riser - Medford
 - Height 200mm **8"** for PX/WX PAT (Field kit)
 - Blade capacity increases to 5.9 m³ **7.7yd³**
- Guarding - Medford
 - Front sweeps (open top) 299 kg **660 lb**
 - Front sweeps (w/ top cover plate) 481 kg **1060 lb**
- Hinged cab side screens 79 kg **175 lb**
- Hinged cab rear screen 91 kg **200 lb**
- Tank guards 404 kg **890 lb**
- Hydraulic winch - Allied H6H
 - 1325 kg **2,900 lb**
- Mechanical angle blade - Rockland
 - 1100 kg **2,425 lb**



AESS868-03

©2018 Komatsu America Corp.

Printed in USA

AD06(1.5M)OTP

06/18 (EV-1)

KOMATSU®

Note: All comparisons and claims of improved performance made herein are made with respect to the prior Komatsu model unless otherwise specifically stated.

www.komatsuamerica.com

Komatsu America Corp. is an authorized licensee of Komatsu Ltd.

Materials and specifications are subject to change without notice

KOMATSU®, Komatsu Care®, KOMTRAX® and KOMTRAX Plus® are registered trademarks of Komatsu Ltd.

All other trademarks and service marks used herein are the property of Komatsu Ltd., Komatsu America Corp. or their respective owners or licensees.

D65EX/PX/WX-18